

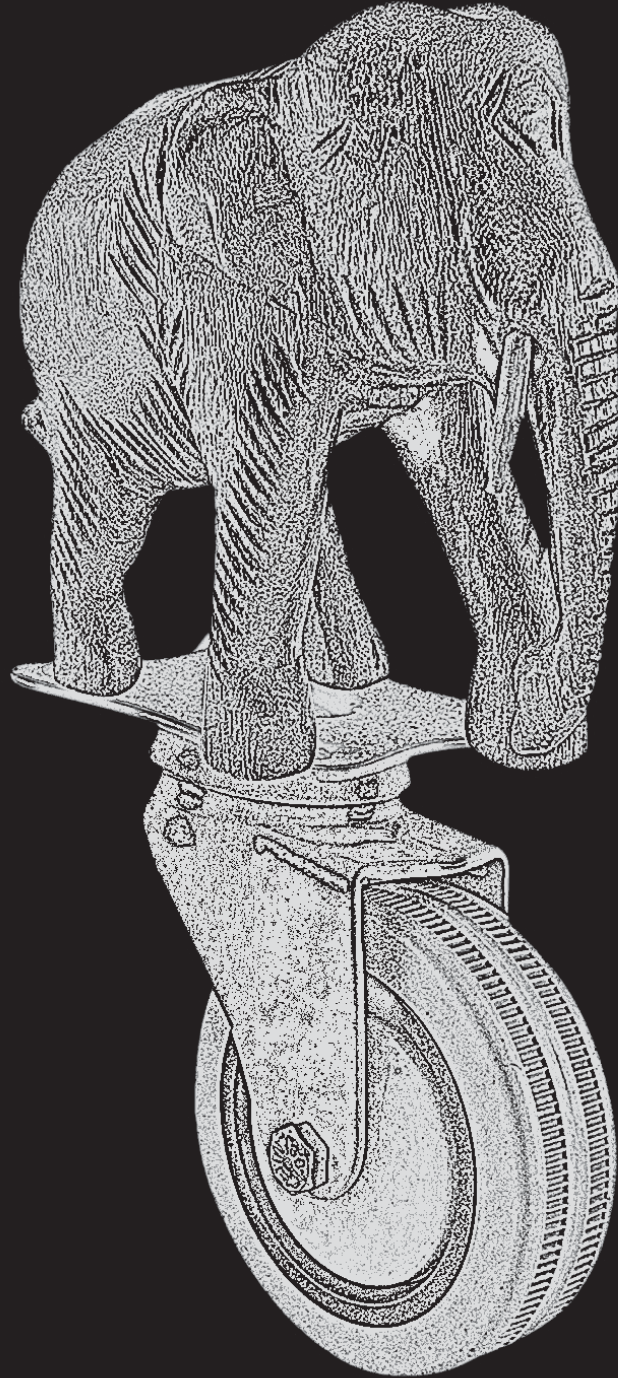

SANAYİ VE MOBİLYA TEKERLEKLERİ
CASTORS & WHEELS FOR FURNITURE



www.ozbekteker.com



Hakkımızda

Firmamız 1967 yılında kurulmuş olup, çeşitli sektörler için metal ve plastik gövdeli tekerlek ve ayak üretmektedir. İkitelli Organize Sanayi Bölgesinde 1200 m² kapalı alanda 500'den fazla ürün çeşidiyle yılda 18.000.000 adet üretim kapasitesine sahiptir.

Ürünlerimiz ev ve büro mobilyalarında, hastane ve hareket ettirilmesi istenen her türlü araç ve gereçte kullanılmaktadır. Kaliteye gerekli önemi gösterildiği ürünlerimiz yurt içi ve yurt dışında pazarlanmaktadır.

About us

Our firm was established in 1967. We are producing plastic and metal furniture castors and feet, especially for metal and wooden office and for hospital and market riggings. We have over than 500 kinds of production items. We are producing annually 18.000.000 piece in 1200 m² covered area in İkitelli Organize Sanayi region. Our products are marketed both in our country and in outer markets.



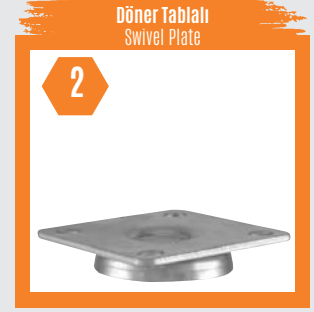

- P** Plipropilen
- L** PVC
- N** Nylon 6
- PS** Sarı Metalize

- FR** Frenli
- KP** Gant Kapaklı
- LTB** L Şeklinde Tabla
- U** U Şeklinde Tabla

- UUZ** U Şeklinde Uzun Tabla
- K** Küçük
- O** Orta
- B** Büyük

- NB** Bakır Kaplama
- AH** Ahşap
- SF** Şeffaf
- GR** Gri
- G** Geniş



Teker	Eni	Delik	Komple	Tabla	Delik	Delik	Pim	Pim	Kendi	Taşıma	Koli
Çapı		Çapı	Boy	Ebadı	Mesafesi	Çapı	Çapı	Boy	Ağırlığı	Kapasitesi	Adet
Wheel	Tread	Hole	Overall	Top Plate	Bolt Hole	Hole	Stem	Stem	Article	Load	Packing
Diameter	Width	Diameter	Height	Size	Spacing	Diameter	Diameter	Height	Weight	Capacity	Units

KİMYASAL DAYANIKLILIK

	Polyamit	Polipropilen	Poliüretan	Pvc	Termo Plastik	Kauçuk
Alkol	++	+	++	-	+	+
Amonyak	++	+	++	-	-	-
Bitkisel Yağlar	++	++	+	+	+	-
Mineral Yağlar	++	+	+	+	+	--
Petrol Ürünleri	++	++	+	+	+	--
Solventler	++	-	--	-	-	-
Su	++	++	++	++	++	++
Sülfürik Asit (%10)	--	++	-	--	+	-
Süt	++	++	++	-	+	-
Tuzlu Su	++	++	++	+	+	+
Sıcaklık	-20 C +80 C	-20 C +60 C	-20 C +60 C	-20 C +70 C	-20 C +60 C	-20 C +60 C

TEKERLEK BAĞLANTI ŞEKİLLERİ

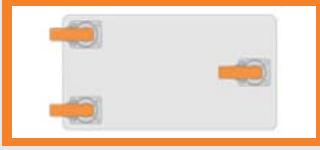

Üç Döner Tekerlek Bağlantı

Hafif yüklerin taşınmasında kullanılır. Dar olan alanlarda manevra kabiliyeti yüksektir. Taşıma arabalarının düz ileri hareket ettirildiğinde arabanın kontrol edilmesi oldukça zordur. Bu tip tekerlek konfigürasyonlarında taşıma arabasının devrilme riski vardır.



Dört Döner Tekerlek Bağlantı

Orta ve ağır yüklerin taşınmasında kullanılır. Dar olan alanlarda manevra kabiliyeti yüksektir. Taşıma arabalarının düz ileri hareket ettirildiğinde kontrolü zayıftır. Tüm yönlerde rahat hareket etmek kabiliyeti sayesinde, dengeli ve en çok tercih edilen tekerlek bağlantı konfigürasyonudur.

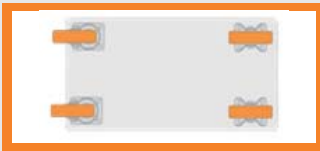

İki Sabit İki Döner Tekerlek Bağlantı

Orta ve ağır yüklerin taşınmasında kullanılır. Dar olan alanlarda manevra kabiliyeti oldukça düşüktür. Taşıma arabalarının düz ileri çekilmesinde manevra kabiliyeti oldukça iyidir.



Dört Sabit Bağlantı

Yüksek konumlandırılmış iki orta tekerlek sayesinde iyi düz sürüş kabiliyeti ve kontrolü vardır. Taşınan yükün ortadaki iki tekerin üzerine konumlandırılığında taşıma arabası sabit haldeyken bulunduğu yerde döndürülebilmektedir. Bu tip tekerlek bağlantılarında taşıma arabasının devrilme riski vardır.



İki Sabit İki Döner Teker Bağlantı

Yüksek konumlandırılmış döner tekerlek sayesinde düz ileri sürüşlerde ve dönemeçlerde manevra kabiliyeti yüksektir. Bu tip tekerlek konfigürasyonlarında taşıma arabasının devrilme riski vardır.



Dört Döner ve İki Sabit Bağlantı

Ağır ve uzun yüklerin taşınmasında idealdir. Düz ileri sürüşlerde ve dönemeçlerde manevra kabiliyeti oldukça yüksektir.





Dünyanın yükünü taşıyoruz...



SABİT TEKERLER / FIXED CASTER

103-N



123-P



133-P



143-P



7.80

1000 Adet

20

8

22

40x12

32

5

-

-

17

20

7.80

1000 Adet

28

14

35

26x20

-

-

-

-

25

18

11.00

500 Adet

32

15

42

36x21

-

-

-

-

36

20

12.00

500 Adet

38

15

45

38x21

-

-

-

-

38

22

163-P



173-P



183-P



183-PYB



10.00

500 Adet

28

14

34

46x21

35

5

-

-

29

15

11.75

350 Adet

32

15

42

53x21

39

5

-

-

43

20

13.00

300 Adet

38

15

48

57x21

45

5

-

-

48

20

13.25

250 Adet

38

15

43

60x21

47

6,5

-

-

54

20



SABİT TEKERLER / FIXED CASTER

193-P



193-L



203-P



203-L



18.50

200 Adet

50

20

53

49X27

-

-

-

-

68

25

24.00

200 Adet

50

20

53

49X27

-

-

-

-

80

30

19.00

125 Adet

50

20

68

67X29

51

7

-

-

93

25

24.50

125 Adet

50

20

68

67X29

51

7

-

-

107

30

203-SF



203-TP



203-LKP



203-LKY



30.00

200 Adet

50

20

68

67X29

51

7

-

-

110

30

23.50

200 Adet

50

20

68

67X29

51

7

-

-

103

30

32.50

125 Adet

50

20

68

67X29

51

7

-

-

115

30

31.00

100 Adet

50

20

71

67x25

45

7

-

-

175

30



SABİT TEKERLER / FIXED CASTER

243-P



243-L



243-SF



243-TP



	27.50	33.00	39.00	32.00
	150 Adet	150 Adet	150 Adet	150 Adet
	50	50	50	50
	20	20	20	20
	74	74	75	75
	50X50	50X50	50X50	50X50
	36X36	36X36	36X36	36X36
	6,5	6,5	6,5	6,5
	-	-	-	-
	-	-	-	-
	102	117	121	113
	35	40	40	40

403-N



403-P



403-L



403-TP



	57.00	43.00	64.00	62.00
	50 Adet	50 Adet	50 Adet	50 Adet
	75	75	75	75
	25	25	25	25
	95	95	95	95
	85X37	85X37	85X37	85X37
	61	61	61	61
	9	9	9	9
	-	-	-	-
	-	-	-	-
	195	197	246	227
	50	40	45	45



SABİT TEKERLER / FIXED CASTER

413-P



413-L



413-TP



- 7
- 8
- 9
- 10
- 11
- 12
- 13
- 14
- 15
- 16
- 17
- 18
- 19
- 20

43.00

50 Adet

75

25

95

85X37

61

9

-

-

197

40

56.00

50 Adet

75

25

95

85X37

61

9

-

-

249

45

54.00

50 Adet

75

25

95

85X37

61

9

-

-

227

45



301-P



302-P



302-PB



302-PBUUZ



22.00

500 Adet

32

14

49

-

-

-

M8

15

56

20

20.00

500 Adet

28

14

39

45X30

36X20

5

-

-

46

20

46.00

250 Adet

28

21

46

42X42

32X32

4,5

-

-

90

25

47.00

250 Adet

28

21

46

72X18

62

4

-

-

109

25

307-P



224-P



19.00

500 Adet

28

14

39

-

-

-

7

40

39

20

17.00

500 Adet

38

15

50

-

-

-

6

26

36

15





TEK SIRA BİLYALI TEKERLER / SINGLE ROW BALL WHEEL

201-P



202-P



202-PU



202-PUUZ



29.50

150 Adet

50

20

70

-

-

-

3/8

16

102

25

29.50

150 Adet

50

20

71

43X39

29X26

4

-

-

115

25

30.50

100 Adet

50

20

68

32X18

-

4

-

-

114

25

31.50

100 Adet

50

20

68

72X18

-

4

-

-

129

25

201-L



202-L



202-LU



202-LUUZ



35.00

150 Adet

50

20

72

-

-

-

3/8

16

113

30

35.00

150 Adet

50

20

71

43X39

29X26

4

-

-

125

30

36.00

100 Adet

50

20

68

32X18

-

4

-

-

125

30

37.00

100 Adet

50

20

68

72X18

61

4

-

-

141

30

201-SF



202-SF



202-SFU



202-SFUUZ



41.00

150 Adet

50

20

70

-

-

-

3/8

16

119

30

41.00

150 Adet

50

20

71

43X39

29X26

4

-

-

131

30

42.00

150 Adet

50

20

68

32X18

-

4

-

-

128

30

43.00

150 Adet

50

20

68

72X18

61

4

-

-

144

30

201-TP



202-TP



202-TPU



202-TPUUZ



34.00

150 Adet

50

20

70

-

-

-

3/8

16

111

30

34.00

150 Adet

50

20

70

43X39

29X26

4

-

-

123

30

35.00

150 Adet

50

20

68

32X18

-

4

-

-

121

30

36.00

150 Adet

50

20

68

72X18

61

4

-

-

137

30

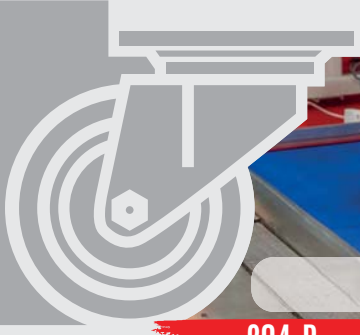

TEK SIRA BİLYALI TEKERLER / SINGLE ROW BALL WHEEL

204-P



204-L



204-SF



204-TP



27.00

150 Adet

50

20

60

-

-

-

8,3

27

82

25

32.50

150 Adet

50

20

60

-

-

-

8,3

27

94

30

38.50

150 Adet

50

20

60

-

-

-

8,3

27

98

30

31.50

150 Adet

50

20

60

-

-

-

8,3

27

90

30



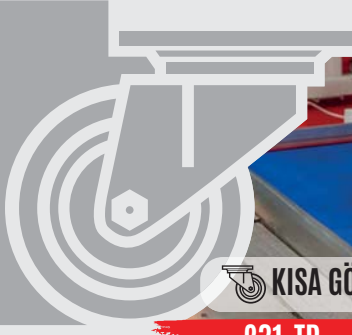

KISA GÖVDE ÇİFT SIRA BİLYALI TEKERLER/ SHORT BODY DOUBLE ROW BALL WHEEL

231-TP



232-TP



232-TPDT



41.50

150 Adet

50

20

73

-

-

-

3/8

16

109

30

42.50

150 Adet

50

20

69

43X39

29X26

4

-

-

116

30

43.50

150 Adet

50

20

69

64X33

48

6,5

-

-

115

30



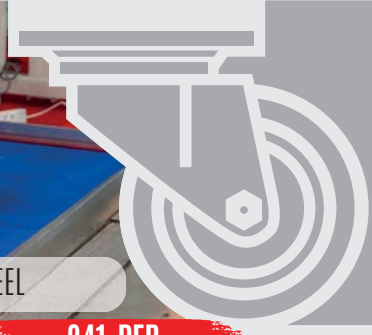

240-P



240-PFR



241-P



241-PFR



44.00

150 Adet

50

20

71

-

-

-

M8-M10

-

111

35

60.00

150 Adet

50

20

71

-

-

-

M8-M10

-

130

35

44.00

150 Adet

50

20

79

-

-

-

3/8

16

128

35

60.00

150 Adet

50

20

79

-

-

-

3/8

16

145

35

242-P



242-PFR



242-PUUZ



242-PUUZFR



45.50

100 Adet

50

20

74

50x50

36x36

7

-

-

150

35

61.50

100 Adet

50

20

74

50x50

36x36

-

-

169

35

48.00

100 Adet

50

20

75

72x18

61

4

-

-

156

35

64.00

100 Adet

50

20

75

72x18

61

4

-

-

175

35



ÇİFT SIRA BİLYALI TEKERLER / DOUBLE ROW BALL WHEEL

242-PUG



242-PUG FR



244-P



244-PFR



50.00

80 Adet

50

20

74

35X50

-

4

-

-

156

35

66.00

80 Adet

50

20

74

35X50

-

4

-

-

174

35

45.00

150 Adet

50

20

72

-

-

-

8,3

27

128

35

61.00

150 Adet

50

20

72

-

-

-

8,3

27

147

35

245-P



245-PFR



240-L



240-LFR



46.00

150 Adet

50

20

75

-

-

-

11

21

136

35

62.00

150 Adet

50

20

75

-

-

-

11

21

154

35

50.00

150 Adet

50

20

71

-

-

-

M8-M10

-

125

40

67.00

150 Adet

50

20

71

-

-

-

M8-M10

-

143

40

241-L



241-LFR



242-L



242-LFR



	241-L	241-LFR	242-L	242-LFR
₺	50.00	67.00	51.50	68.50
Adet	150 Adet	150 Adet	100 Adet	100 Adet
Ø	50	50	50	50
H	20	20	20	20
Ø ₁	78	78	74	74
Ø ₂	-	-	50X50	50X50
Ø ₃	-	-	36X36	36X36
Ø ₄	-	-	6,5	6,5
Ø ₅	3/8	3/8	-	-
Ø ₆	16	16	-	-
Ø ₇	144	161	166	182
Ø ₈	40	40	40	40

242-LUUZ



242-LUUZFR



242-LUG



242-LUGFR



	242-LUUZ	242-LUUZFR	242-LUG	242-LUGFR
₺	54.00	71.00	56.00	73.00
Adet	100 Adet	100 Adet	80 Adet	80 Adet
Ø	50	50	50	50
H	20	20	20	20
Ø ₁	74	74	74	74
Ø ₂	72x18	72x18	35x50	35x50
Ø ₃	62	62	-	-
Ø ₄	4	4	4	4
Ø ₅	-	-	-	-
Ø ₆	-	-	-	-
Ø ₇	167	184	167	186
Ø ₈	40	40	40	40



ÇİFT SIRA BİLYALI TEKERLER / DOUBLE ROW BALL WHEEL

244-L



244-LFR



245-L



245-LFR



51.00

150 Adet

50

20

72

-

-

-

8,3

27

140

40

68.00

150 Adet

50

20

72

-

-

-

8,3

27

157

40

52.00

150 Adet

50

20

75

-

-

-

11

21

149

40

69.00

150 Adet

50

20

75

-

-

-

11

21

165

40

241-TP



241-TPFR



242-TP



242-TPFR



49.00

150 Adet

50

20

78

-

-

-

3/8

16

138

40

66.00

150 Adet

50

20

78

-

-

-

3/8

16

157

40

50.50

100 Adet

50

20

74

50x50

36x36

6,5

-

-

161

40

67.50

100 Adet

50

20

74

50x50

36x36

6,5

-

-

179

40

242-TPUUZ



242-TPUUZFR



244-TP



244-TPFR



	53.00	70.00	49.00	66.00
📦	90 Adet	90 Adet	150 Adet	150 Adet
📏	50	50	50	50
📏	20	20	20	20
📏	74	74	72	72
📏	72x18	72x18	-	-
📏	62	62	-	-
📏	4	4	-	-
📏	-	-	8,3	8,3
📏	-	-	27	27
📏	161	178	136	153
📏	40	40	40	40

245-TP



245-TPFR



	50.00	67.00
📦	150 Adet	150 Adet
📏	50	50
📏	20	20
📏	75	75
📏	-	-
📏	-	-
📏	-	-
📏	11	11
📏	21	21
📏	145	161
📏	40	40



ÇİFT SIRA BİLYALI ÇİFTLİ TEKERLER / DOUBLE ROW BALL DOUBLE WHEEL

210-P



210-PFR



211-P



211-PFR



57.00

75 Adet

50

20

71

-

-

-

M8-M10

-

203

40

81.00

75 Adet

50

20

71

-

-

-

M8-M10

-

236

40

57.00

75 Adet

50

20

76

-

-

-

3/8

16

224

40

81.00

75 Adet

50

20

76

-

-

-

3/8

16

257

40

212-P



212-PFR



210-L



210-LFR



62.00

50 Adet

50

20

73

65X65

48X48

8

-

-

289

40

86.00

50 Adet

50

20

73

65X65

48X48

8

-

-

317

40

73.00

75 Adet

50

20

71

-

-

-

M8-M10

-

231

50

98.00

75 Adet

50

20

71

-

-

-

M8-M10

-

260

50

211-L



211-LFR



212-L



212-LFR



73.00

75 Adet

50

20

76

-

-

-

3/8

16

248

50

98.00

75 Adet

50

20

76

-

-

-

3/8

16

281

50

78.00

50 Adet

50

20

73

65X65

48X48

8

-

-

309

50

103.00

50Adet

50

20

73

65X65

48X48

8

-

-

341

50

210-N



210-NFR



211-N



211-NFR



72.00

75 Adet

50

20

71

-

-

-

M8-M10

206

50

97.00

75 Adet

50

20

71

-

-

-

M8-M10

240

50

72.00

75 Adet

50

20

76

-

-

-

3/8

16

229

50

97.00

75 Adet

50

20

76

-

-

-

3/8

16

262

50



ÇİFT SIRA BİLYALI ÇİFTLİ TEKERLER / DOUBLE ROW BALL DOUBLE WHEEL

212-N



212-NFR



210-SF



210-SFFR



77.00

50 Adet

50

20

73

65X65

48X48

8

-

-

289

50

102.00

50 Adet

50

20

73

65X65

48X48

8

-

-

320

50

85.00

75 Adet

50

20

73

-

-

-

M8-M10

-

236

50

110.00

75 Adet

50

20

73

-

-

-

M8-M10

-

268

50

211-SF



211-SFFR



212-SF



212-SFFR



85.00

75 Adet

50

20

73

-

-

-

3/8

16

257

50

110.00

75 Adet

50

20

73

-

-

-

3/8

16

287

50

90.00

50 Adet

50

20

73

65X65

48X48

8

-

-

315

50

115.00

50 Adet

50

20

73

65X65

48X48

8

-

-

346

50



ÇİFT SIRA BİLYALI ÇİFTLİ TEKERLER / DOUBLE ROW BALL DOUBLE WHEEL

210-TP



210-TPFR



211-TP



211-TPFR



71.00

75 Adet

50

20

71

-

-

-

M8-M10

220

50

96.00

75 Adet

50

20

71

-

-

-

M8-M10

250

50

71.00

75 Adet

50

20

76

-

-

-

3/8

16

241

50

96.00

75 Adet

50

20

76

-

-

-

3/8

16

270

50

212-TP



212-TPFR



76.00

50 Adet

50

20

73

65X65

48X48

8

-

-

301

50

101.00

50 Adet

50

20

73

65X65

48X48

8

-

-

330

50



75'LİK ÇİFT SIRA BİLYALI TEKERLER / DOUBLE ROW BALL WHEEL

özбек®
SANAYİ VE MOBİLYA TEKERLEKLERİ
CASTORS & WHEELS FOR FURNITURE
Dünyanın yükünü taşıyoruz..

400-N



400-NFR



401-N



401-NFR



70.00

50 Adet

75

25

95

-

-

-

M8-M10

-

194

50

90.00

50 Adet

75

25

95

-

-

-

M8-M10

-

218

50

70.00

50 Adet

75

25

100

-

-

-

3/8

16

213

50

90.00

50 Adet

75

25

100

-

-

-

3/8

16

238

50

402-N



402-NFR



403-N



400-L



73.00

50 Adet

75

25

98

65X65

47X47

8

-

-

250

50

93.00

50 Adet

75

25

98

65X65

47X47

8

-

-

278

50

57.00

50 Adet

75

25

95

85X37

61

9

-

-

246

45

77.00

50 Adet

75

25

95

-

-

-

M8-M10

-

240

50



75'LİK ÇİFT SIRA BİLYALI TEKERLER / DOUBLE ROW BALL WHEEL

400-LFR



401-L



401-LFR



402-L



97.00

50 Adet

75

25

95

-

-

-

M8-M10

-

271

50

77.00

50 Adet

75

25

100

-

-

-

3/8

16

263

50

97.00

50 Adet

75

25

100

-

-

-

3/8

16

290

50

80.00

50 Adet

75

25

98

65X65

47X47

8

-

-

300

50

402-LFR



403-L



400-TP



400-TPFR



100.00

50 Adet

75

25

98

65X65

47X47

8

-

-

326

50

64.00

50 Adet

75

25

95

85X37

61

9

-

-

246

45

75.00

50 Adet

75

25

95

-

-

-

M8-M10

-

251

50

95.00

50 Adet

75

25

95

-

-

-

M8-M10

-

276

50



75'LİK ÇİFT SIRA BİLYALI TEKERLER / DOUBLE ROW BALL WHEEL

özbeK[®]
SANAYİ VE MOBİLYA TEKERLEKLERİ
CASTORS & WHEELS FOR FURNITURE
Dünyanın yükünü taşıyoruz..

401-TP



401-TPFR



402-TP



402-TPFR



75.00

50 Adet

75

25

100

-

-

-

3/8

16

275

50

95.00

50 Adet

75

25

100

-

-

-

3/8

16

298

50

78.00

50 Adet

75

25

98

65X65

47X47

8

-

-

310

50

98.00

50 Adet

75

25

100

65X65

47X47

8

-

-

336

50

403-TP



62.00

50 Adet

75

25

95

85X37

61

9

-

-

258

45

Sabit Maşalı Teker
Fixed caster



501-P



502-P



501-L



502-L



54.00

150 Adet

40

∅

58

-

-

-

3/8

16

126

35

54.00

150 Adet

40

∅

55

43X39

29X26

4

-

-

134

35

58.00

150 Adet

40

∅

58

-

-

-

3/8

16

133

40

58.00

150 Adet

40

∅

55

43X39

29X26

4

-

-

140

40

511-P



512-P



514-P



511-L



47.00

150 Adet

40

∅

62

-

-

-

3/8

16

128

30

47.00

150 Adet

40

∅

62

43X39

29X26

4

-

-

140

30

40.00

150 Adet

40

∅

50

-

-

-

8,3

27

95

25

51.00

150 Adet

40

∅

62

-

-

-

3/8

16

134

35



BİLYALI KÜRE TEKERLER / ROW BALL SPHERE WHEELS

özbeK[®]
SANAYİ VE MOBİLYA TEKERLEKLERİ
CASTORS & WHEELS FOR FURNITURE
Dünyanın yükünü taşıyoruz..

512-L



514-L



551-L



552-L



51.00

150 Adet

40

Ø

62

43X39

29X26

4

-

-

146

35

44.00

150 Adet

40

Ø

50

-

-

-

8,3

27

114

30

82.00

100 Adet

50

Ø

71

-

-

-

3/8

16

233

50

83.00

100 Adet

50

Ø

69

50X50

36X36

6,5

-

-

258

50

555-L

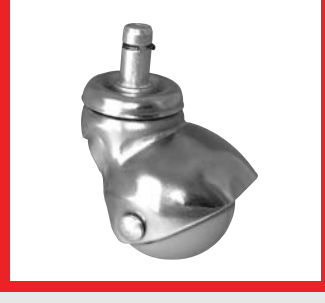

84.00

100 Adet

50

Ø

69

-

-

-

11

21

236

50





SANAYİ VE MOBİLYA TEKERLEKLERİ
CASTORS & WHEELS FOR FURNITURE

www.ozbekteker.com

Dünyanın yükünü taşıyoruz..



34'LÜK PLASTİK TEKERLER / 34 mm PLASTIC WHEELS

özbeK[®]
SANAYİ VE MOBİLYA TEKERLEKLERİ
CASTORS & WHEELS FOR FURNITURE
Dünyanın yükünü taşıyoruz..

821-N



822-N



822-NGR



824-N



11.40

600 Adet

34

11x2

49

-

-

-

5/16

12

33

15

12.20

500 Adet

34

11x2

52

34x34

24x24

4

-

-

41

15

14.00

500 Adet

34

11x2

52

34x34

24x24

4

-

-

41

15

11.40

600 Adet

34

11x2

45

-

-

-

7

22

33

15

826-N



11.40

600 Adet

34

11x2

45

-

-

-

7

17

32

15



831-N



832-N



832-NGR



832-NU



12.60

500 Adet

38

12x2

50

-

-

-

5x16

13

38

20

13.40

400 Adet

38

12x2

53

34x34

24x24

4

-

-

46

20

15.40

400 Adet

38

12x2

53

34x34

24x24

4

-

-

46

20

16.50

300 Adet

38

12x2

51

32x18

-

4

-

-

58

20

834-N



836-N



837-N



13.00

500 Adet

38

12x2

46

-

-

-

7

22

39

20

13.00

500 Adet

38

12x2

46

-

-

-

7

17

37

20

13.50

500 Adet

38

12x2

46

-

-

-

7

40

44

20

841-NFR



842-NFR



842-NGRFR



842-NUFR



18.50

350 Adet

40

13x2

51

-

-

-

5/16

13

48

20

19.30

350 Adet

40

13x2

53

34x34

24x24

4

-

-

56

20

22.00

350 Adet

40

13x2

53

34x34

24x24

4

-

-

56

20

22.50

300 Adet

40

13x2

52

32x18

-

4

-

-

64

20

842-NUZFR



844-NFR



846-NFR



847-NFR



23.80

300 Adet

40

13x2

55

72x18

61

4

-

-

82

20

18.60

350 Adet

40

13x2

47

-

-

-

7

22

48

20

18.60

350 Adet

40

13x2

47

-

-

-

7

17

48

20

19.10

300 Adet

40

13x2

47

-

-

-

7

45

52

20

801-NFR



802-NFR



802-NGRFR



802-NUFR



25.50

200 Adet

50

18x2

60

-

-

-

3/8

15

81

30

27.00

200 Adet

50

18x2

62

43x39

29x26

4

-

-

91

30

31.00

200 Adet

50

18x2

62

43x39

29x26

4

-

-

91

30

29.00

200 Adet

50

18x2

63

32x18

-

4

-

-

94

30

802-NUBFR



802-NUZFR



804-NFR



805-NFR



30.50

200 Adet

50

18x2

63

35x30 / 35x25

-

4

-

-

97

30

30.50

200 Adet

50

18x2

63

72x18

61

4

-

-

112

30

27.00

200 Adet

50

18x2

53

-

-

-

8,3

36

83

30

27.50

200 Adet

50

18x2

57

-

-

-

11

21

87

30



50'LİK PLASTİK TEKERLER / 50 mm PLASTIC WHEELS

851-N



852-N



852-NU



852-NUB



21.25

200 Adet

50

19x2

66

-

-

-

3/8

15

82

35

23.25

150 Adet

50

19x2

69

45x45

32x32

4

-

-

104

35

24.50

150 Adet

50

19x2

69

32x18

-

4

-

-

98

35

26.00

150 Adet

50

19x2

69

35x30 / 35x25

-

4

-

-

99

35

852-NUG



852-NUUZ



854-N



855-N



27.25

150 Adet

50

19x2

69

35x50

-

4

-

-

113

35

26.00

150 Adet

50

19x2

69

72x18

61

4

-

-

113

35

23.00

200 Adet

50

19x2

58

-

-

-

8,3

36

82

35

22.75

200 Adet

50

19x2

65

-

-

-

11

21

88

35

855-NGR



851-NFR



852-NFR



852-NUFR



26.00

200 Adet

50

19x2

65

-

-

-

11

21

88

35

26.75

150 Adet

50

19x2

66

-

-

-

3/8

15

87

35

28.75

150 Adet

50

19x2

69

45x45

32x32

4

-

-

110

35

30.00

150 Adet

50

19x2

69

32x18

-

4

-

-

104

35

852-NUBFR



852-NUGFR



852-NUZFR



854-NFR



31.50

150 Adet

50

19x2

69

35x30 / 35x25

-

4

-

-

104

35

32.75

150 Adet

50

19x2

69

35x50

-

4

-

-

118

35

31.50

150 Adet

50

19x2

69

72x18

61

4

-

-

118

35

28.50

150 Adet

50

19x2

58

-

-

-

8,3

36

89

35



50'LİK PLASTİK TEKERLER / 50 mm PLASTIC WHEELS

855-NFR



855-NGRFR



861-N



862-N



28.25

150 Adet

50

19x2

65

-

-

-

11

21

94

35

32.00

150 Adet

50

19x2

65

-

-

-

11

21

93

35

21.25

200 Adet

50

19x2

65

-

-

-

3/8

15

78

35

23.25

150 Adet

50

19x2

68

45x45

32x32

4

-

-

92

35

862-NU



862-NUB



862-NUUZ



864-N



24.50

150 Adet

50

19x2

68

32x18

-

4

-

-

94

35

26.00

150 Adet

50

19x2

68

35x30 / 35x25

-

4

-

-

94

35

26.00

150 Adet

50

19x2

68

72x18

61

4

-

-

108

35

23.00

200 Adet

50

19x2

57

-

-

-

8,3

36

78

35

865-N

865-NGR

861-NFR

862-NFR

	865-N	865-NGR	861-NFR	862-NFR
₺	22.75	26.00	26.75	28.75
Adet	200 Adet	200 Adet	200 Adet	150 Adet
Ø	50	50	50	50
Ø	19x2	19x2	19x2	19x2
Ø	64	64	65	68
Ø	-	-	-	45x45
Ø	-	-	-	32x32
Ø	-	-	-	4
Ø	11	11	3/8	-
Ø	21	21	15	-
Ø	84	86	83	105
Ø	35	35	35	35

862-NUFR

862-NUBFR

862-NUZFR

864-NFR













	862-NUFR	862-NUBFR	862-NUZFR	864-NFR
₺	30.00	31.50	31.50	28.50
Adet	150 Adet	150 Adet	150 Adet	150 Adet
Ø	50	50	50	50
Ø	19x2	19x2	19x2	19x2
Ø	68	68	68	57
Ø	32x18	35x30 / 35x25	72x18	-
Ø	-	-	61	-
Ø	4	4	4	-
Ø	-	-	-	8,3
Ø	-	-	-	36
Ø	100	100	114	83
Ø	35	35	35	35



 50'LİK PLASTİK TEKERLER / 50 mm PLASTIC WHEELS

865-NFR



	28.25
	150 Adet
	50
	19x2
	64
	-
	-
	-
	11
	21
	89
	35





SANAYİ VE MOBİLYA TEKERLEKLERİ
CASTORS & WHEELS FOR FURNITURE

www.ozbekteker.com



Dünyanın yükünü taşıyoruz..

www.ozbekteker.com



50'LİK PLASTİK TEKERLER / 50 mm PLASTIC WHEELS

871-N



872-N



872-NU



872-NUB



37.00

200 Adet

50

16x2

70

-

-

-

3/8

15

92

30

39.00

175 Adet

50

16x2

71

45X45

32X32

-

-

-

113

30

40.50

150 Adet

50

16x2

71

32x18

-

4

-

-

108

30

42.00

150 Adet

50

16x2

71

35X30 / 35X25

-

4

-

-

108

30

872-NUG



872-NUUZ



874-N



875-N



43.75

125 Adet

50

16x2

71

35X50

-

4

-

-

124

30

42.00

150 Adet

50

16x2

71

72X18

61

4

-

-

124

30

39.00

200 Adet

50

16x2

62

-

-

-

8,3

36

91

30

39.50

200 Adet

50

16x2

66

-

-

-

11

21

98

30

875-N (Siyah)



871-NFR



872-NFR



872-NUFR



39.50

200 Adet

50

16x2

66

-

-

-

11

21

98

30

43.00

200 Adet

50

16x2

70

-

-

-

3/8

15

97

30

45.00

150 Adet

50

16x2

71

45X45

32X32

4

-

-

119

30

46.50

150 Adet

50

16x2

71

32X18

-

4

-

-

110

30

872-NUBFR



872-NUGFR



872-NUZFR



874-NFR



48.00

150 Adet

50

16x2

71

35X30 / 35X25

-

4

-

-

114

30

49.75

125 Adet

50

16x2

71

35X50

-

4

-

-

129

30

48.00

150 Adet

50

16x2

71

72X18

61

4

-

-

130

30

45.00

175 Adet

50

16x2

62

-

-

8,3

36

98

30



50'LİK PLASTİK TEKERLER / 50 mm PLASTIC WHEELS

875-NFR



875-NFR (Siyah)



45.50

175 Adet

50

16x2

66

-

-

-

11

21

102

30

45.50

175 Adet

50

16x2

66

-

-

-

11

21

102

30



601-N



602-N



602-NU



602-NUB



32.00

150 Adet

60

18x2

68

-

-

-

3/8

15

94

35

34.00

150 Adet

60

18x2

72

45X45

32X32

4

-

-

116

35

35.00

150 Adet

60

18x2

70

32X18

-

4

-

-

110

35

36.50

150 Adet

60

18x2

71

35X30 / 35X25

-

4

-

-

111

35

602-NUUZ



604-N



605-N



601-NFR



36.50

125 Adet

60

18x2

71

72X18

61

4

-

-

125

35

34.00

150 Adet

60

18X2

60

-

-

-

8,3

36

94

35

33.50

150 Adet

60

18X2

67

-

-

-

11

21

99

35

38.00

150 Adet

60

18X2

68

-

-

-

3/8

15

98

35



60'LİK PLASTİK TEKERLER / 60 mm PLASTIC WHEELS

602-NFR



602-NUFR



602-NUBFR



602-NUUZF



40.00

150 Adet

60

18x2

72

45X45

32X32

4

-

-

120

35

41.00

125 Adet

60

18x2

70

32X18

-

4

-

-

114

35

42.50

125 Adet

60

18x2

71

35X30 / 35X25

-

4

-

-

112

35

42.50

125 Adet

60

18x2

71

72X18

61

4

-

-

130

35

604-NFR



605-NFR



651-N



652-N



40.00

150 Adet

60

18x2

60

-

-

-

8,3

36

97

35

39.50

150 Adet

60

18x2

67

-

-

-

11

21

103

35

34.00

150 Adet

60

18x2

68

-

-

-

3/8

15

94

35

36.00

150 Adet

60

18x2

72

45X45

32X32

4

-

-

116

35

652-NU



652-NUB



652-NUUZ



654-N



37.50

150 Adet

60

18x2

70

32X18

-

4

-

-

110

35

39.00

125 Adet

60

18x2

71

35X30 / 35X25

-

4

-

-

111

35

39.00

125 Adet

60

18x2

71

72X18

61

4

-

-

125

35

36.00

150 Adet

60

18x2

60

-

-

-

8,3

36

94

35

655-N



651-NFR



652-NFR



652-NUFR



35.50

150 Adet

60

18x2

67

-

-

-

11

21

99

35

40.00

150 Adet

60

18x2

68

-

-

-

3/8

15

98

35

40.00

150 Adet

60

18x2

72

45X45

32X32

4

-

-

120

35

40.00

125 Adet

60

18x2

70

32X18

-

4

-

-

114

35



60'LİK PLASTİK TEKERLER / 60 mm PLASTIC WHEELS

özbeK[®]
SANAYİ VE MOBİLYA TEKERLEKLERİ
CASTORS & WHEELS FOR FURNITURE
Dünyanın yükünü taşıyoruz..

652-NUBFR



652-NUUZFR



654-NFR



655-NFR



43.50

125 Adet

60

18x2

71

35X30 / 35X25

-

4

-

-

112

35



43.50

125 Adet

60

18x2

71

72X18

61

4

-

-

130

35

42.00

150 Adet

60

18x2

60

-

-

-

8,3

36

97

35

41.50

150 Adet

60

18x2

67

-

-

-

11

21

103

35

671-N



672-N



672-NU



672-NUB



40.00

175 Adet

60

15x2

68

-

-

-

3/8

15

91

35



42.00

175 Adet

60

15x2

72

45X45

32X32

4

-

-

114

35

43.00

150 Adet

60

15x2

70

32X18

-

4

-

-

108

35

44.50

150 Adet

60

15x2

71

35X30 / 35X25

-

4

-

-

108

35

672-NUUZ



674-N



675-N



671-NFR



44.50

150 Adet

60

18x2

71

72X18

61

4

-

-

122

35

42.00

175 Adet

60

18x2

60

-

-

-

8,3

36

92

35

41.50

175 Adet

60

18x2

67

-

-

-

11

21

97

35

46.00

175 Adet

60

18x2

68

-

-

-

3/8

15

96

35

672-NFR



672-NUFR



672-NUBFR



672-NUUZFR



48.00

175 Adet

60

18x2

72

45X45

32X32

4

-

-

117

35

49.00

150 Adet

60

18x2

70

32X18

-

4

-

-

111

35

50.50

150 Adet

60

18x2

71

35X30 / 35X25

-

4

-

-

109

35

50.50

150 Adet

60

18x2

71

72X18

61

4

-

-

127

35



60'LİK PLASTİK TEKERLER / 60 mm PLASTIC WHEELS

674-NFR



48.00

175 Adet

60

18x2

60

-

-

-

8,3

36

94

35

675-NFR



47.50

175 Adet

60

18x2

67

-

-

-

11

21

100

35

675-N (Siyah)



41.50

175 Adet

60

18x2

67

-

-

-

11

21

97

35

675-NFR (Siyah)



47.50

175 Adet

60

18x2

67

-

-

-

11

21

100

35

675-N (Gri-Siyah)



41.50

175 Adet

60

18x2

67

-

-

-

11

21

97

35

675-NFR (Gri-Siyah)



47.50

175 Adet

60

18x2

67

-

-

-

11

21

100

35

881-N



882-N



881-NFR

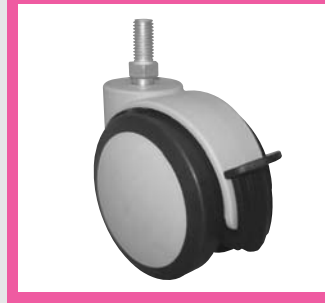

882-NFR



77.00

80 Adet

75

22X2

92

-

-

-

M10

20

175

60

79.00

60 Adet

75

22X2

97

64X64

48X48

8

-

-

241

60

85.00

80 Adet

75

22X2

92

-

-

-

M10

20

186

60

87.00

60 Adet

75

22X2

97

64X64

48X48

8

-

-

251

60



SANAYİ VE MOBİLYA TEKERLEKLERİ
CASTORS & WHEELS FOR FURNITURE

www.ozbekteker.com

Dünyanın yükünü taşıyoruz..

www.ozbekteker.com

201-PE



202-PE



201-LE



202-LE



	24.50	24.50	26.00	26.00
🔧	200 Adet	200 Adet	200 Adet	200 Adet
📏	50	50	50	50
📏	20	20	20	20
📏	70	71	70	71
📏	-	43X39	-	43X39
📏	-	29X26	-	29X26
📏	-	4	-	4
🔧	M8	-	M8	-
🔧	16	-	16	-
🔧	83	84	88	88
🔧	20	20	20	20

411-P



411-PFR



411-PUZ



411-PUZFR



	52.00	69.00	52.00	69.00
🔧	50 Adet	50 Adet	125 Adet	100 Adet
📏	75	75	75	75
📏	25	25	25	25
📏	100	100	96	96
📏	-	-	-	-
📏	-	-	-	-
📏	-	-	-	-
🔧	3/8	3/8	M8	M8
🔧	16	16	50	50
🔧	208	234	208	236
🔧	30	30	30	30



EKO SERİSİ / ECO SERIES

411-L



411-LFR



411-LUZ



411-LUZFR



64.00

50 Adet

75

25

100

-

-

-

3/8

16

236

35

82.00

50 Adet

75

25

100

-

-

-

3/8

16

261

35

64.00

125 Adet

75

25

96

-

-

-

M8

50

240

35

82.00

100 Adet

75

25

96

-

-

-

M8

50

266

35

412-P



412-PFR



412-L



412-LFR



58.00

50 Adet

75

25

98

65X65

47X47

8

-

-

245

30

75.00

50 Adet

75

25

98

65X65

47X47

8

-

-

270

30

69.00

50 Adet

75

25

98

65X65

47X47

8

-

-

273

35

87.00

50 Adet

75

25

98

65X65

47X47

8

-

-

298

35

411-TP



411-TPFR



412-TP



412-TPFR



62.00

50 Adet

75

25

100

-

-

-

3/8

16

244

35

80.00

50 Adet

75

25

100

-

-

-

3/8

16

268

35

67.00

50 Adet

75

25

98

65X65

47X47

8

-

-

280

35

85.00

50 Adet

75

25

98

65X65

47X47

8

-

-

303

35

413-P



413-L



413-TP



511-PE



43.00

50 Adet

75

25

92

85X38

60

9

-

-

192

30

55.00

50 Adet

75

25

92

85X38

60

9

-

-

220

35

53.00

50 Adet

75

25

92

85X38

60

9

-

-

227

35

27.00

150 Adet

40

∅

61

-

-

-

3/8

16

115

25

844-PFR



801-P



801-PFR



802-P



14.75

400 Adet

40

13X2

47

-

-

-

7

25

48

15

13.80

250 Adet

50

18X2

60

-

-

-

3/8

15

72

25

18.80

200 Adet

50

18X2

60

-

-

-

3/8

15

78

25

14.60

200 Adet

50

18X2

62

43X39

29X26

4

-

-

82

25

802-PFR



802-PU



802-PUFR



802-PUB



19.60

200 Adet

40

18X2

62

43X39

29X26

4

-

-

88

25

16.75

200 Adet

50

18X12

63

32X18

-

4

-

-

85

25

21.75

200 Adet

50

18X2

63

32X18

-

4

-

-

93

25

18.25

200 Adet

50

18X2

63

35X30 / 35X25

-

4

-

-

89

25



EKO SERİSİ / ECO SERIES

802-PUUZ



802-PUUZFR



804-P



804-PFR



18.25

200 Adet

50

18X2

63

72X18

61

4

-

-

103

25

23.25

200 Adet

50

18X2

63

72X18

61

4

-

-

109

25

15.25

250 Adet

450

18X12

53

-

-

-

8,3

36

72

25

20.25

200 Adet

50

18X2

53

-

-

-

8,3

36

83

25

805-P



805-PFR



851-P



852-P



15.75

250 Adet

50

18X2

57

-

-

-

11

21

78

25

20.75

200 Adet

50

18X2

57

-

-

-

11

21

83

25

15.20

200 Adet

50

19X2

66

-

-

-

3/8

15

83

30

16.30

150 Adet

50

19X2

69

45X45

32X32

4

-

-

104

30

852-PU



852-PUB



852-PUUZ



854-P



17.90

150 Adet

50

19X2

69

32X18

-

4

-

-

98

30

19.20

150 Adet

50

19X2

69

35X30 / 35X25

-

4

-

-

98

30

19.20

150 Adet

50

19X2

69

72X18

-

4

-

-

115

30

16.30

200 Adet

50

19X2

58

-

-

-

8,3

36

82

30

855-P



17.00

200 Adet

50

19X2

65

-

-

-

11

21

88

30

Dünyanın yükünü taşıyoruz..





SANAYİ VE MOBİLYA TEKERLEKLERİ
CASTORS & WHEELS FOR FURNITURE

www.ozbekteker.com

Dünyanın yükünü taşıyoruz..

921-P



922-P



922-PU



924-P



12.30



200 Adet



62



Ø



47



-



-



-



3/8



15



62



40

13.80

200 Adet

62

Ø

50

43X39

29X26

4

-

-

71

40

15.80

150 Adet

62

Ø

49

32X18

-

4

-

-

78

40

13.80

200 Adet

62

Ø

40

-

-

-

8,3

30

61

40

926-P



981-P



982-P



982-PU



10.50



200 Adet



62



Ø



40



-



-



-



12



22



48



40

13.80

175 Adet

63

Ø

62

-

-

-

3/8

15

68

50

15.30

175 Adet

63

Ø

64

45X45

32X32

4

-

-

90

50

17.30

150 Adet

63

Ø

63

32X18

-

4

-

-

84

50



AYAK SERİSİ / LEG SERIES

984-P



986-P



931-N



932-N



15.30

175 Adet

63

Ø

54

-

-

-

8,3

35

67

50

13.90

175 Adet

63

Ø

57

-

-

-

12

26

67

50

11.00

300 Adet

50

Ø

40

-

-

-

3/8

15

49

25

12.50

250 Adet

50

Ø

41

43X39

29X26

4

-

-

59

25

932-NU



934-N



935-N



936-N



14.50

250 Adet

50

Ø

41

35X19

-

4

-

-

65

25

12.50

300 Adet

50

Ø

34

-

-

-

8,3

34

49

25

13.00

300 Adet

50

Ø

37

-

-

-

11

21

55

25

12.50

300 Adet

50

Ø

37

-

-

-

12

26

48

25

GÖMME TEKER

956-P



966-P



975-P



9.00

150 Adet

48

∅

53

-

-

-

12

30

42

50

10.00

80 Adet

76

∅

38

-

-

-

12

25

63

50

10.00

500 Adet

44

∅

21

-

-

-

11

21

40

30

14.00

800 Adet

∅

∅

10

-

-

-

35

-

18

15

910-PK



910-PO



910-PB



10.50

1000 Adet

36

∅

15

-

-

-

-

-

16

40

12.75

1000 Adet

47

∅

15

-

-

-

-

29

40

15.50

300 Adet

53

∅

16

-

-

-

-

39

40



AYAK SERİSİ / LEG SERIES

971-PM



971-PK



971-PO



971-PB



4.25

1500 Adet

28

Ø

13

-

-

-

M8

15

14

20

8.40

500 Adet

40

Ø

18

-

-

-

3/8

23

31

30

7.50

500 Adet

40

Ø

23

-

-

-

M8-M10

27

31

30

11.00

500 Adet

46

Ø

25

-

-

-

3/8

20

36

30

971-PMGR



971-PKGR



971-POGR



971-PBGR



4.80

1500 Adet

28

Ø

13

-

-

-

M8

15

14

20

9.60

500 Adet

40

Ø

18

-

-

-

3/8

23

31

30

8.60

500 Adet

40

Ø

23

-

-

-

M8-M10

27

31

30

12.60

500 Adet

46

Ø

25

-

-

-

3/8

20

36

30

991-PK



995-PK



991-P0



991-PB



10.50

1500 Adet

25

∅

17

-

-

-

M8-M10

15

14

25

11.50

1500 Adet

25

∅

17

-

-

-

11

15

22

25

11.70

1000 Adet

32

∅

18

-

-

-

M8-M10

15

16

30

11.00

750 Adet

50

∅

13

-

-

-

M8-M10

20

41

30

991-PKKP



991-POKP



995-POKP



991-PBKP



13.80

1500 Adet

25

∅

17

-

-

-

M8-M10

15

14

25

15.70

1000 Adet

32

∅

18

-

-

-

M8-M10

15

16

30

16.70

1000 Adet

32

∅

18

-

-

-

11

15

27

30

15.50

750 Adet

50

∅

13

-

-

-

M8-M10

20

41

30



LÜKENS AYAK / LUKENS FOOT

BEYAZ



₺

24.00

KREM



27.00

SİYAH



24.00

KIRMIZI



27.00

KAHVERENGİ



₺

27.00

AKÇA AĞAÇ



CEVİZ



KOYU MEŞE



Ø



Ø



140



140X140



88



75



50



20X8 P



28X14P



32X15 P



38X15 P



2.50

2000 Adet

20

8

5

-

-

-

-

-

2

-

3.00

1000 Adet

28

14

5

-

-

-

-

-

5

-

3.40

1000 Adet

32

15

5

-

-

-

-

-

6

-

4.00

1000 Adet

38

15

5

-

-

-

-

-

9

-

50X20 P



50X20 N



50X20 L



50X20 SF



5.00

500 Adet

50

20

6

-

-

-

-

-

19

-

10.00

500 Adet

50

20

6

-

-

-

-

-

21

-

11.80

500 Adet

50

20

6

-

-

-

-

-

33

-

20.00

500 Adet

50

20

6

-

-

-

-

-

36

-



YEDEK TEKERLER / SPARE WHEELS

50X20 TP



75X25 P



75X25 N



75X25 L

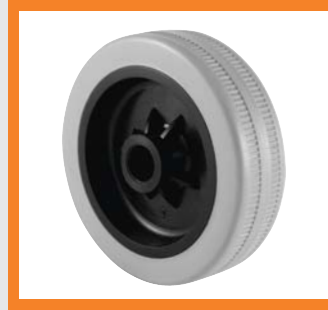

- 🔧
- 📦
- 📏
- 🔗
- 🔄
- 📦
- 📏
- 📦
- 🔧
- 🔗
- 🔄
- 📦
- 📏
- 📦

10.80

500 Adet

50

20

6

-

-

-

-

-

28

-

10.50

250 Adet

75

25

6

-

-

-

-

-

40

-

20.00

250 Adet

75

25

6

-

-

-

-

-

63

-

22.50

250 Adet

75

25

10

-

-

-

-

-

72

-

75X25 TP



40-P



40-L



50-L



- 🔧
- 📦
- 📏
- 🔗
- 🔄
- 📦
- 📏
- 📦
- 🔧
- 🔗
- 🔄
- 📦
- 📏
- 📦

20.50

250 Adet

75

25

6

-

-

-

-

-

78

-

8.25

250 Adet

40

40

6

-

-

-

-

28

-

10.70

250 Adet

40

40

6

-

-

-

-

35

-

15.25

200 Adet

50

50

6

-

-

-

-

68

-

16 Ø



6000 Adet



2.30

19 Ø



5000 Adet



2.40

21 Ø



4000 Adet



2.50

25 Ø



2500 Adet



2.90

16 Ø



5000 Adet



2.40

16 Ø UZ



5000 Adet



2.50

20X20



3000 Adet



2.40

20X20



2500 Adet



2.50

20X20 UZ



2000 Adet



2.60



PİM BAŞLIKLARI / PLASTIC SOCKET

25X25



1500 Adet



2.80

20X30



1500 Adet



2.80

40X40



750 Adet



3.60

10'LUK KISA



5000 Adet



1.87

10'LUK UZUN



2500 Adet



1.97

13'LÜK



3000 Adet



1.87

H02-34



Pimli Tabla



3.25



1000 Adet



34x34



24x24



4



5/16

H02-38



Pimli Tabla



5.00



1000 Adet



43x38



29x26



4



3/8

H02-45



Pimli Tabla



6.50



1000 Adet



45x45



32x32



4



3/8

H02-64



Pimli Tabla



12.00



1000 Adet



64x64



48x48



8



10

H02-U18



Pimli Tabla



8.00



1000 Adet



32x18



4



3/8

H02-U18K



Pimli Tabla



7.75



1000 Adet



32x18



4



5/16

H02-U22



Pimli Tabla



9.00



1000 Adet



35x22



4



3/8

H02-U25



Pimli Tabla



10.00



1000 Adet



35x25



4



3/8



H02-U30



Pimli Tabla



10.00



1000 Adet



35x30



4



3/8

H02-U50

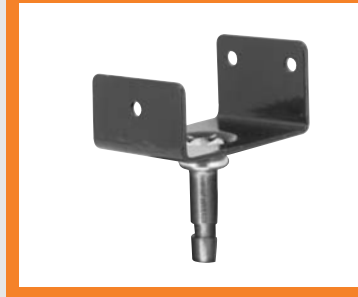

Pimli Tabla



11.00



1000 Adet



35x50



4



3/8

H02-L



Pimli Tabla



8.00



1000 Adet



50x18



4



3/8

H02-UUZ



Pimli Tabla



9.00



1000 Adet



72x18



4



3/8

H02-DİT15



Pimli Tabla



2.50



1000 Adet



15x48



4



M8

H02-DİT45



Pimli Tabla



5.20



1000 Adet



45x45



32x32



4



M8

H02-DİT60

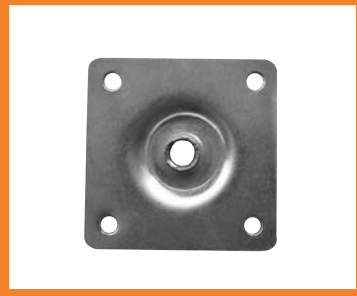

Pimli Tabla



9.00



1000 Adet



60x60



44x44



5



3/8

H02-DİT80

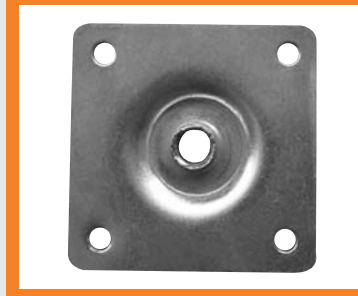

Pimli Tabla



16.50



1000 Adet



80x80



60x60



4



3/8

H01-5/16

Pimli Tabla



3.30



1000 Adet



5/16



M8



13



6/80

H01-3/8

Pimli Tabla



4.40



1000 Adet



3/8



M8-M10



15



8,30

H01-M10

Pimli Tabla



10.00



1000 Adet



M10



M8



20



9,80

 PİMLER / PINS**H04**

Pimli Tabla



5.00



1000 Adet



3/8



8,30

H05

Pimli Tabla



6.00



1000 Adet



11



21



8,30

H06

Pimli Tabla



3.50



1000 Adet



5/16



17



6,80

H07

Pimli Tabla



4.00



1000 Adet



5/16



40



6,80



TAPALAR / PLUGS



KOD		₺
13 Ø iç	5000 Adet	0.70
16 Ø iç	4000 Adet	0.79
19 Ø iç	4000 Adet	0.85
21 Ø iç	3000 Adet	0.90



KOD		₺
15X15 iç	7500 Adet	0.70
20X20 iç	4000 Adet	0.80
25X25 iç	2000 Adet	0.90
30X30 iç	1000 Adet	0.35



KOD		₺
22 Ø iç	2500 Adet	0.96
25 Ø iç	2000 Adet	1.00
28 Ø iç	2000 Adet	1.18
32 Ø iç	1500 Adet	1.32



KOD		₺
40X40 iç	500 Adet	2.20
50X50 iç	400 Adet	5.30
60X60 iç	250 Adet	5.60
80X80 iç	150 Adet	8.00



KOD		₺
38 Ø iç	1500 Adet	3.38
42 Ø iç	500 Adet	3.62
48 Ø iç	500 Adet	4.30
51 Ø iç	400 Adet	4.80



KOD		₺
15X25 iç	3000 Adet	0.94
20X30 iç	2500 Adet	0.80
20X40 iç	1500 Adet	0.90



KOD		₺
60 Ø iç	300 Adet	5.30
76 Ø iç	250 Adet	10.00



KOD		₺
30X40 iç	1250 Adet	1.45
30X50 iç	1000 Adet	3.30
40X60 iç	500 Adet	4.80

**KOD****₺**

13 Ø DIŞ	4000 Adet	0.73
16 Ø DIŞ	4000 Adet	0.85
19 Ø DIŞ	3000 Adet	0.86
21 Ø DIŞ	2000 Adet	0.90

**KOD****₺**

20X20 DIŞ	1250 Adet	0.98
25x25 DIŞ	1000 Adet	1.18
30X30 DIŞ	750 Adet	1.49
40X40 DIŞ	500 Adet	2.66

**KOD****₺**

22 Ø DIŞ	2000 Adet	0.94
25 Ø DIŞ	1500 Adet	1.03
28 Ø DIŞ	1500 Adet	1.35
32 Ø DIŞ	1000 Adet	1.45

**KOD****₺**

20X30 DIŞ	2000 Adet	1.88
20X40 DIŞ	1500 Adet	3.55

**KOD****₺**

15X30 iç Elips	2500 Adet	0.94
20X40 iç Elips	1500 Adet	1.13
25X50 iç Elips	1000 Adet	1.88

**KOD****₺**

K. DIŞLI	3000 Adet	0.98
B. DIŞLI	2000 Adet	1.22



ROTİL TAKIM

özbeK[®]
SANAYİ VE MOBİLYA TEKERLEKLERİ
CASTORS & WHEELS FOR FURNITURE
Dünyanın yükünü taşıyoruz..



KOD	Adet	₺
20X20 Rotil M8	500 Adet	9.40
25X25 Rotil M8	500 Adet	10.30
20X30 Rotil M8	500 Adet	10.70
20X40 Rotil 3/8	400 Adet	12.00



KOD	Adet	₺
30X30 Rotil M10	400 Adet	13.00
30X40 Rotil M10	300 Adet	16.40
30X40 Rotil M12	300 Adet	18.60



KOD	Adet	₺
50X50 Rotil M16	200 Adet	40.00
40X60 Rotil M12	200 Adet	33.75
60X60 Rotil M16	200 Adet	36.00

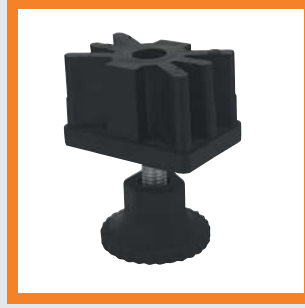

KOD	Adet	₺
30X50 Rotil M10	300 Adet	18.80
30X60 Rotil M10	250 Adet	19.80



KOD	Adet	₺
32 Ø Rotil M10	500 Adet	15.00
38 Ø Rotil M10	300 Adet	15.80



KOD	Adet	₺
40X40 Rotil M10	150 Adet	14.50
40X40 Rotil M12	150 Adet	18.80



KOD			
20X20	Rotil Üst M8	1000 Adet	5.90
20X30	Rotil Üst M8	800 Adet	6.00
20X40	Rotil Üst M8	750 Adet	6.80
25X25	Rotil Üst M8	800 Adet	6.80



KOD			
40x40	Rotil Üst M10	400 Adet	7.80
40x40	Rotil Üst M12	400 Adet	8.50
50x50	Rotil Üst M10	400 Adet	14.40
60x60	Rotil Üst M16	300 Adet	19.00



KOD			
30X30	Rotil Üst M10	750 Adet	7.40
30X30	Rotil Üst 3/8	750 Adet	7.50
30X40	Rotil Üst M10	500 Adet	9.00



KOD			
30X50	Rotil Üst M10	500 Adet	9.50
30X60	Rotil Üst M10	400 Adet	11.00
40X60	Rotil Üst M10	400 Adet	18.00
40x60	Rotil Üst M12	400 Adet	23.60

ROTİL ALT



KOD			
35 Ø	Rotil Pingo M8	600 Adet	7.50
35 Ø	Rotil Pingo M10	600 Adet	8.25
45 Ø	Rotil Pingo M10	300 Adet	8.50
45 Ø	Rotil Pingo M12	250 Adet	12.00



KOD			
55 Ø	Rotil Pingo M10	500 Adet	15.00
55 Ø	Rotil Pingo M12	500 Adet	18.00
55 Ø	Rotil Pingo M16	400 Adet	30.00

 **özbeK**[®]
SANAYİ VE MOBİLYA TEKERLEKLERİ
CASTORS & WHEELS FOR FURNITURE
www.ozbekteker.com

Dünyanın yükünü taşıyoruz..

www.ozbekteker.com



KOD	Ø	H	GR	KG	₺	KOD	Ø	H	GR	KG	₺
SP 080	80	25	180	60	58.00	SP 150	150	40	775	130	135.00
SP 100	100	30	295	75	63.00	SP 200	200	50	1650	180	217.00
SP125	125	37,5	545	110	106.00						



KOD	Ø	H	GR	KG	₺	KOD	Ø	H	GR	KG	₺
ZK 080	80	25	75	120	28.00	ZK 150	150	40	300	180	102.00
ZK 100	100	30	110	140	40.00	ZK 200	200	50	851	750	276.00
ZK 125	125	37,5	220	160	72.50						



KOD	Ø	H	GR	KG	₺	KOD	Ø	H	GR	KG	₺
HK 055	55	25	34	150	15.00	HK 125	125	40	370	400	97.00
HK 080	80	30	130	200	42.00	HK150	150	45	540	550	138.00
HK 100	100	35	235	350	68.00	HK 200	200	50	1100	750	276.00



KOD	Ø	H	GR	KG	₺	KOD	Ø	H	GR	KG	₺
ZKP 080	80	30	125	110	65.00	ZKP 150	150	40	525	170	209.00
ZKP 100	100	30	189	130	98.00	ZKP 200	200	50	975	750	425.00
ZKP 125	125	37,5	371	150	150.00						



KOD	Ø	H	GR	KG	₺	KOD	Ø	H	GR	KG	₺
VK 055	55	25	270	150	78.00	VK 125	125	40	1730	400	500.00
VK 080	80	30	680	200	180.00	VK 150	150	45	2912	550	515.00
VK 100	100	35	1250	350	275.00	VK 200	200	50	5490	950	1.240.00

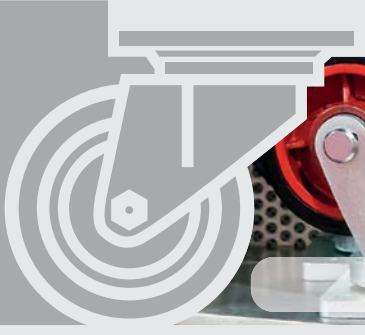

SANAYİ TEKERLERİ / INDUSTRIAL WHEELS

özбек®
SANAYİ VE MOBİLYA TEKERLEKLERİ
CASTORS & WHEELS FOR FURNITURE
Dünyanın yükünü taşıyoruz..



KOD									₺
01 SP 080	80	25	106	85X100	60X80	695	60	143.50	
01 SP 100	100	30	127	85X100	60X80	835	75	152.00	
01 SP 125	125	37,5	157	85X100	60X100	1240	110	219.00	
01 SP 150	150	40	181	85X100	60X80	1523	130	251.50	
01 SP 200	200	50	242	115X141	80X105	3214	180	453.00	



KOD								₺
01 SP 080 F	80	25	106	85X100	60X80	852	60	198.00
01 SP 100 F	100	30	127	85X100	60X80	994	75	204.00
01 SP 125 F	125	37,5	157	85X100	60X80	1407	110	266.00
01 SP 150 F	150	40	181	85X100	60X80	1685	130	301.00
01 SP 200 F	200	50	242	115X141	80X105	3498	180	517.00



KOD								₺
02 SP 080	80	25	106	85X100	60X80	395	60	108.50
02 SP 100	100	30	127	85X100	60X80	535	75	116.00
02 SP 125	125	37,5	157	85X100	60X80	970	110	188.00
02 SP 150	150	40	181	85X100	60X80	1235	130	220.00
02 SP 200	200	50	242	115X141	80X105	3005	180	395.00











KOD								₺
01 ZK 080	80	30	106	85X100	60X80	592	120	114.00
01 ZK 100	100	30	127	85X100	60X80	661	140	128.00
01 ZK 125	125	37,5	157	85X100	60X80	915	160	185.00
01 ZK 150	150	40	181	85X100	60X80	1044	180	221.00
01 ZK 200	200	50	242	115X141	80X105	2412	230	490.00











KOD								₺
01 ZK 080 F	80	30	106	85X100	60X80	647	120	169.00
01 ZK 100 F	100	30	127	85X100	60X80	809	140	183.00
01 ZK 125 F	125	37,5	157	85X100	60X80	1082	160	246.00
01 ZK 150 F	150	40	181	85X100	60X80	1231	180	270.00
01 ZK 200 F	200	50	242	115X141	80X105	2670	230	550.00











KOD									₺
02 ZK 080	80	30	106	85X100	60X80	285	120		80.00
02 ZK 100	100	30	127	85X100	60X80	340	140		95.00
02 ZK 125	125	37,5	157	85X100	60X80	640	160		153.00
02 ZK 150	150	40	181	85X100	60X80	780	180		188.00
02 ZK 200	200	50	242	115X141	80X105	2010	230		431.00











KOD									₺
01 HK 055	55	25	80	70X86	45X66	455	150		97.00
01 HK 080	80	30	115	92X118	61X90	1159	200		284.00
01 HK 100	100	35	140	115X140	81X105	2006	350		402.00
01 HK 125	125	40	170	115X140	81X105	2353	400		460.00
01 HK 150	150	45	206	115X140	81X105	2915	550		650.00
01 HK 200	200	50	248	115X140	81X105	3540	750		836.00











KOD									₺
01 HK 055 F	55	25	80	70X86	45X66	490	150		133.00
01 HK 080 F	80	30	115	92X118	61X90	1500	200		413.00
01 HK 100 F	100	35	140	115X140	81X105	2455	350		520.00
01 HK 125 F	125	40	170	115X140	81X105	2832	400		575.00
01 HK 150 F	150	45	206	115X140	81X105	3355	550		830.00
01 HK 200 F	200	50	248	115X140	81X105	3910	750		1.015.00



KOD									₺
02 HK 055	55	25	80	70X86	45X66	325	150		78.00
02 HK 080	80	30	115	92X118	61X90	815	200		162.00
02 HK 100	100	35	140	115X140	81X105	1520	350		270.00
02 HK 125	125	40	170	115X140	81X105	1820	400		319.00
02 HK 150	150	45	206	115X140	81X105	2145	550		368.00
02 HK 200	200	50	248	115X140	81X105	2785	750		550.00



KOD									₺
01 ZKP 080	80	30	106	85X100	60X80	650	120		140.00
01 ZKP P100	100	30	127	85X100	60X80	731	140		164.00
01 ZKP 125	125	37,5	157	85X100	60X80	1053	160		250.00
01 ZKP 150	150	40	181	85X100	60X80	1243	180		355.00
01 ZKP 200	200	50	242	115X141	80X105	2544	230		630.00

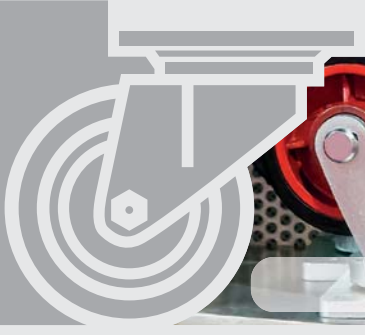

SANAYİ TEKERLERİ / INDUSTRIAL WHEELS

özбек®
SANAYİ VE MOBİLYA TEKERLEKLERİ
CASTORS & WHEELS FOR FURNITURE
Dünyanın yükünü taşıyoruz..



KOD								₺
01 ZKP 080 F	80	30	106	85X100	60X80	804	120	195.00
01 ZK P100 F	100	30	127	85X100	60X80	888	140	218.00
01 ZKP 125 F	125	37,5	157	85X100	60X80	1231	160	300.00
01 ZKP 150 F	150	40	181	85X100	60X80	1614	180	405.00
01 ZKP 200 F	200	50	242	115X141	80X105	2720	230	695.00



KOD								₺
02 ZKP 080	80	30	106	85X100	60X80	337	120	106.00
02 ZKP 100	100	30	127	85X100	60X80	411	140	130.00
02 ZKP 125	125	37,5	157	85X100	60X80	791	160	218.00
02 ZKP 150	150	40	181	85X100	60X80	973	180	320.00
02 ZKP 200	200	50	242	115X141	80X105	2069	230	575.00



KOD								₺
01 VK 055	55	25	80	70X86	45X66	687	150	160.00
01 VK 080	80	30	115	92X118	61X90	1713	200	410.00
01 VK 100	100	35	140	115X140	81X105	3070	350	604.00
01 VK 125	125	40	170	115X140	81X105	3983	400	845.00
01 VK 150	150	45	206	115X140	81X105	5165	550	1.015.00
01 VK 200	200	50	248	115X140	81X105	7711	950	1.745.00



KOD								₺
01 VK 055 F	55	25	80	70X86	45X66	715	150	195.00
01 VK 080 F	80	30	115	92X118	61X90	2104	200	540.00
01 VK 100 F	100	35	140	115X140	81X105	3514	350	720.00
01 VK 125 F	125	40	170	115X140	81X105	4402	400	955.00
01 VK 150 F	150	45	206	115X140	81X105	5605	550	1.195.00
01 VK 200 F	200	50	248	115X140	81X105	8064	950	1.925.00

 **özbeK**[®]
SANAYİ VE MOBİLYA TEKERLEKLERİ
CASTORS & WHEELS FOR FURNITURE

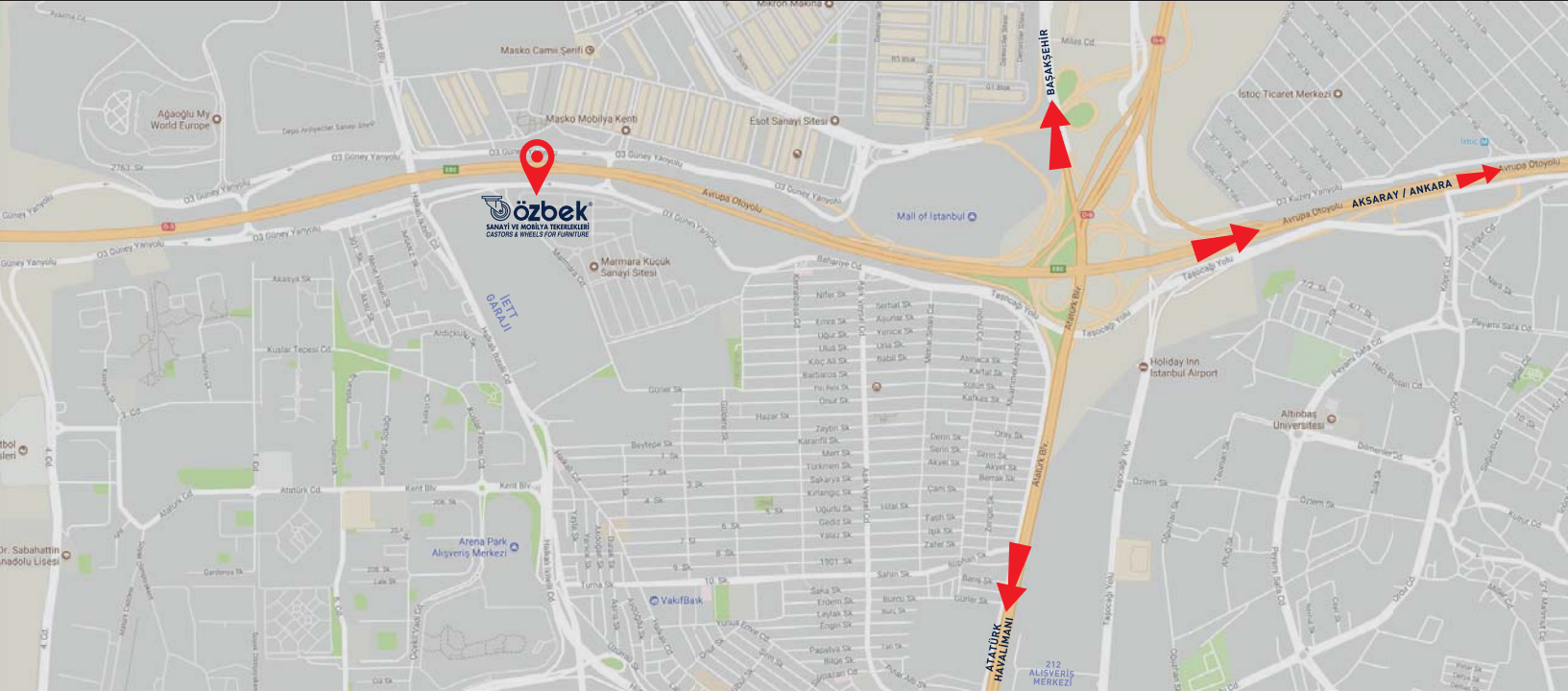

www.ozbekteker.com



Dünyanın yükünü taşıyoruz...



ÖZBEK TEKER SANAYİİ VE TİCARET

İkitelli O.S.B. Mah. Marmara Sanayi Sitesi A Blok No:6 Küçükçekmece - İST. / TÜRKİYE

Tel: +90 212 472 00 13 (3 Hat) Fax: +90 212 472 00 16

e-mail: info@ozbekteker.com

www.ozbekteker.com



Özbek
00312 4720013